

400 SERIES REMOTE AMPLIFIER SIREN W/ HANDHELD REMOTE

ETSA461HPP - 100W
ETSA462HPP - 200W

Microphone,
Lights and Siren
Controller



Amplifier Box

PSRN4ANR1 100W
PSRN4ANR2 200W



HANDHELD SIREN CONTROLLER
PSRNHHC1

⚠️ WARNING

- HIGH CURRENT interconnects must be properly terminated. Poor crimp quality can cause heat build-up and fire. Follow crimp connector manufacturer instructions.
- DO NOT install this product or route any wires in the Air Bag Deployment Zone. Refer to vehicle Owner's Manual for deployment zones.
- Do NOT use system to disconnect headlights, brake lights or other safety equipment.
- Unit may become hot to touch during normal operation.
- Failure to properly install connectors, fuses or wiring may cause vehicle failure or fire.
- Installation must only be performed by trained technician. Installer must determine vehicle wiring configuration and proper integration of system.
- Use proper wire gauge. All power wires connecting to positive (+) or negative (-) battery terminal or local chassis ground (-) must be sized to supply at least 125% of max. current and properly fused at power source.
- Install protective grommets when routing wire through firewall or metal.

⚠️ WARNING

Sirens produce loud sounds that may damage hearing:

- Roll up windows.
- Wear hearing protection.
- Use only for emergency response.
- Avoid exposure to siren sound outside of vehicle.



Package Contents:

- 1 ea. Amplifier Box
- 1 ea. Handheld Controller
- 1 ea. Cradle with Mounting Hardware
- 5 ea. Amplifier Wire Harnesses with Connectors (1-4 pin, 1-12 pin, 1-5 pin, 1-14 pin and 1-8 pin)
- 1 ea. Instruction Manual
- 1 ea. Operators Warning Card to remain in vehicle for operator review
- 1 ea. Sound Pressure Warning Label that is to be attached in vehicle and in plain site of operator and occupants of the vehicle
- 1 ea. Label Card for Aux. Switches
- 1 ea. Harness Coupler

Please see page 3 for
Technical Specifications

IMPORTANT NOTICE TO INSTALLER:

Make sure to read and understand all instructions and warnings before proceeding with the installation of this product. Ensure the manual and all warning cards are delivered to the end user of this equipment.

Introduction

The ETSA46(x)HPP is a remote mounted siren amplifier designed for a single (ETSA461) or dual (ETSA462) external speaker. The amplifier box is controlled with a hand held remote containing a noise-cancelling microphone for PA use. The ETSA462 contains a 2 channel amplifier for driving 2 independent sounds. The ETSA461 is a single 100w design. The controller offers 3 multiple programmable levels as well as 6 independently controlled accessory switches.

Notice

Sirens provide an essential function of an effective audio / visual warning system. However, sirens are only short range secondary devices. The use of a siren does not insure that all drivers can or will abide by or react to an emergency warning signal, especially at high rates of speeds or long distances. The operator of the vehicle must never take the right of way for granted and it is the operator's responsibility to proceed safely.

The effectiveness of this siren system is highly dependant on the correct mounting and wiring. The installer must read and follow the manufacturer's installation instructions and warnings in the manual. The vehicle operator should verify the siren system is securely fastened to the vehicle and properly functioning.

Effective sirens generate loud sound pressure levels that can potentially cause hearing damage. Installers and those around the vehicle need to be aware of the dangers and wear hearing protection whenever the siren system is operating. Vehicle operators and occupants should assess their exposure to siren noise and determine what steps need to be taken to prevent hearing damage.

The siren system is intended for use by authorized personnel only. It is the user's responsibility to ensure they understand and operate the emergency warning devices in compliance with all applicable city, state, and federal laws and regulations. SoundOff Signal assumes no liability for any loss resulting from the use of the siren system.

NOTICE:

Installers and users must comply with all applicable federal, state and local laws regarding use and installation of warning devices.

*Improper use or installation may void warranty coverage. To review our Limited Warranty Statement & Return Policy for this or any SoundOff Signal product, visit our website at www.soundoffsignal.com/support/. If you have questions regarding this product, contact **Technical Services**, Monday - Friday, 8 a.m. to 5 p.m. or after hours 5 p.m. to 8 p.m. Eastern at 1.800.338.7337 (press #4 to skip the automated message). Questions or comments that do not require immediate attention may be emailed to techservices@soundoffsignal.com.*



400 SERIES REMOTE AMPLIFIER SIREN W/ HANDHELD REMOTE

ETSA461HPP - 100W

ETSA462HPP - 200W

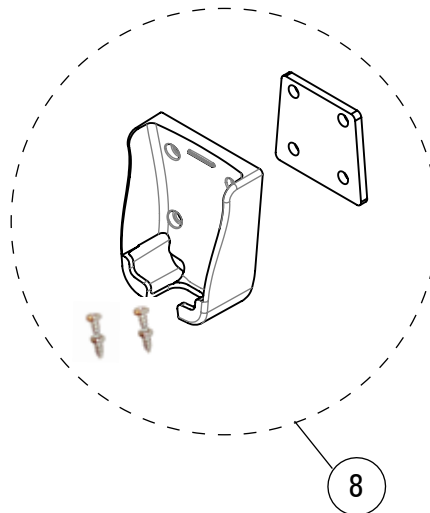
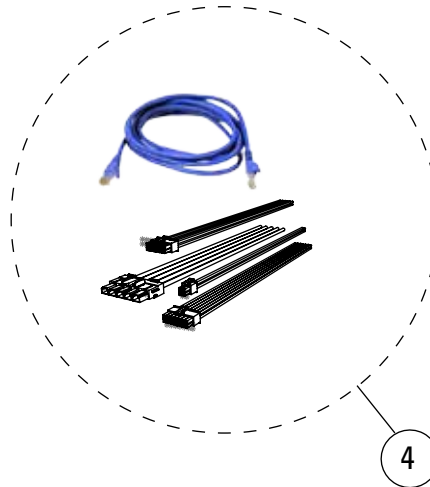
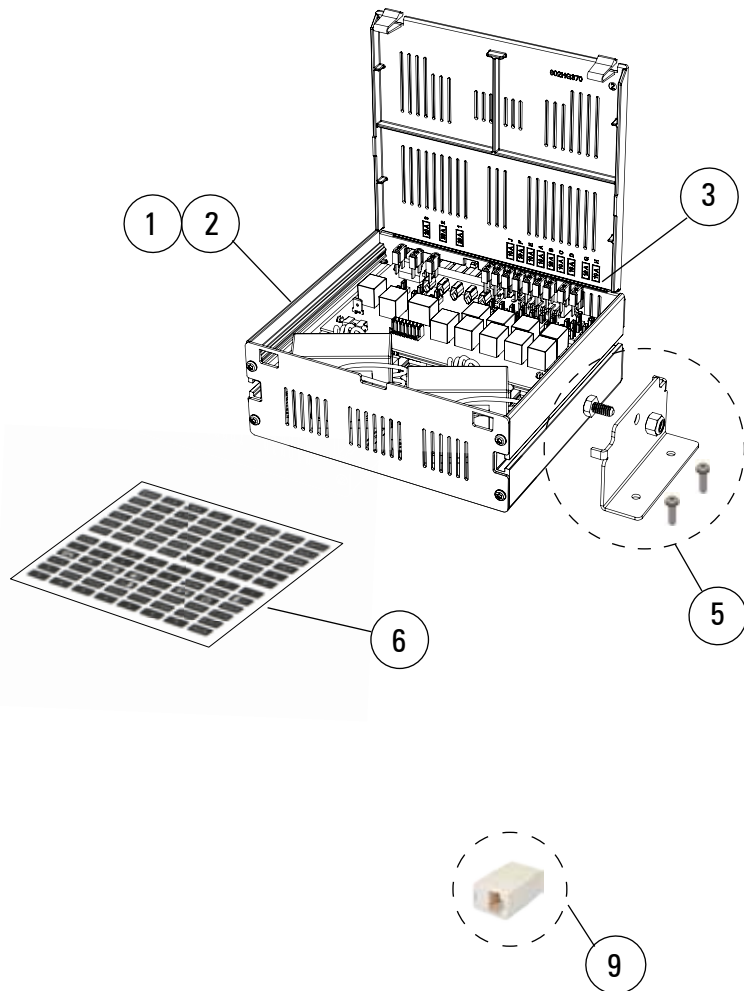

Replacement Parts & Accessories:

- | | | |
|---|------------|---|
| 1 | PSRN4ANR1 | Replacement Amp/Relay Assembly-100 Watt |
| 2 | PSRN4ANR2 | Replacement Amp/Relay Assembly-200 Watt |
| 3 | PSRN4HDK2 | Fuse Kit |
| 4 | PSRN4HDK1 | Harness Kit |
| 5 | PSRN4MTBK1 | Mounting Bracket |
| 6 | PSRNLEG2 | Auxiliary Button Legends-Handheld |
| 7 | PSRNHHC1 | Handheld Remote |
| 8 | PSRNHHBK1 | Bracket Remote Holster |
| 9 | PSRN4RJC1 | RJ45 Coupler |



400 SERIES AMPLIFIER BOX

PSRN4ANR1

PSRN4ANR2

Operating Modes

The primary operating modes are User Selectable Tone, Yelp, Wail, Radio and PA. Horn Override and a push-button Manual Override are available in all modes. For California Title 13 compliance all tones except Wail and Yelp may be disabled by programming the siren.

WARNING

Do not install this product or route its wires in the air bag deployment area.

Doing so may cause damage to or reduce effectiveness of the air bag, or create projectile that could cause serious injury or death.

To determine air bag deployment area refer to vehicle manufacturer's manual.

MOUNTING

-Amplifier Installation-

Before drilling holes, check for clearance to prevent damage. Check both sides of the mounting surface before drilling and be aware of any vehicle components or other vital parts that may be damaged during drilling. Install grommets in any wire passage holes.

1. Slide ¼" hex head bolts into siren amplifier t-slots.
2. Place mounting brackets over bolts.
3. Thread ¼" lock nuts onto bolts and tighten down.
4. Use mounting bracket holes to secure amplifier.
5. Install amplifier with clearance from other objects for improved ventilation.



-Holster Installation-

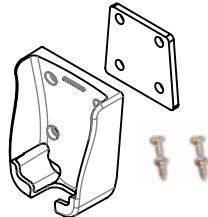

A holster is provided for mounting the hand held remote. Choose a location convenient to the operator and away from any air bag deployment areas. Using the back plate as a template, mark the 4 holes to be drilled. Using a 1/8" drill bit, drill the mounting holes. Install the 4 #6 screws provided with the bracket.

WIRING:

WARNING! All customer supplied wires connecting to the positive terminal of the battery must be sized to supply at least 125% of the maximum operating current and FUSED at the battery to carry that load.

Ensure the siren amplifier / relay unit is mounted in dry, protected environment.

TECHNICAL SPECIFICATIONS

Overall Dimensions: Control Panel: Amplifier/Relay:	3.51"H x 6.98"W x 1.17"D 2.62"H x 7.00"W x 6.51"D
Input Voltage:	10 - 16Vdc (negative ground)
Boxed Weight:	8 lbs.
Operating Temperature:	-40°C to +50°C
Diagnostic LEDs:	Speaker shorted/open, internal fuses open, communications faults, over/under voltage
Siren	
Input Current:	7 Amps @ 13.4 VDC (100W) Speaker 14 Amps @ 13.4VDC (2x100W speakers)
Standby Current: Ignition ON: Ignition OFF:	500mA <1mA
Audio Frequency:	500-3 kHz
Output Power:	ETSA461: 1x100W RMS Max (11 Ohm speaker) ETSA462: 2x100W RMS Max (11 Ohm speaker)
Siren Frequency:	675Hz - 1633Hz
High Voltage Protection:	Limits to < 18V:* *If siren tone is in progress, sound will continue during overvoltage. New siren tone will not activate if voltage is > 18V.
Low Voltage Shutdown:	Voltage <9.0V will cause siren output to cease and will resume when system voltage is >9.5V Tone disable for California Title 13 compliance
	Auxiliary Input connection for remote manual or Hands Free operation
Speaker Protection:	Shorted, Open: Stop output signal, preserve Amp
Light Control	
AUX Button Relays:	9 total 10A max each circuit, total current not to exceed 50A for CN8 pin 5 2 of the 9 available for external arrow control 2 of the 9 have their source voltage switchable from internal to external via fuse location, see pg5
Slide Switch Relays:	3 total 20A max each circuit, total current not to exceed 50A for CN8 pin 4

SoundOff
Signal

400 SERIES AMPLIFIER BOX

PSRN4ANR1
PSRN4ANR2

SIREN AUDIO WIRING

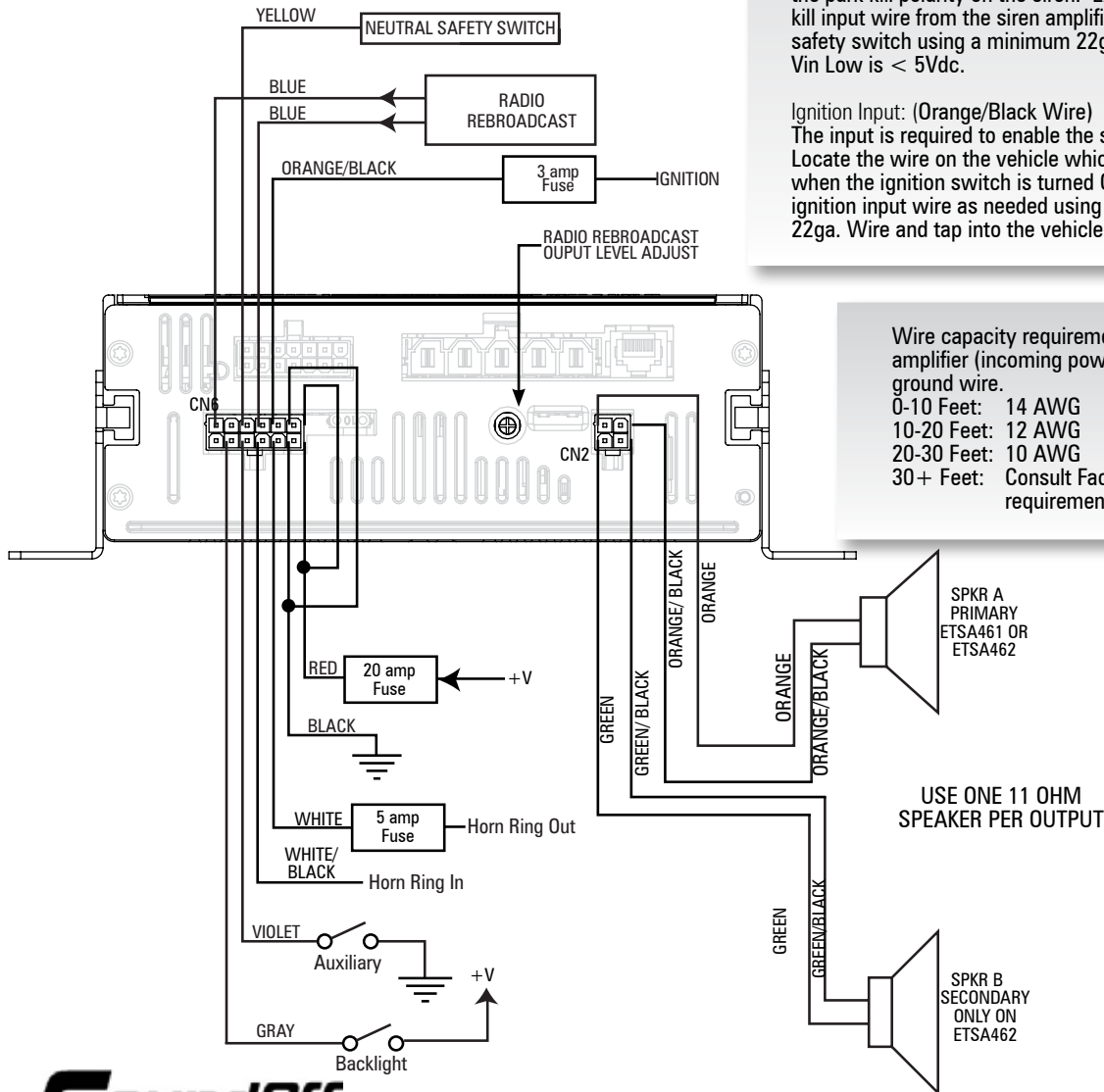

Park Kill Input: (Yellow Wire)

The input will silence the siren tone when the input wire is activated. The input is typically connected to the transmission neutral safety switch. If this feature is required, the installer needs to determine if the signal wire from the neutral safety switch is switching the +V or ground side of the circuit. Refer to the programming instructions on how to set the park kill polarity on the siren. Extend the park kill input wire from the siren amplifier to the neutral safety switch using a minimum 22ga. Wire. Park kill Vin Low is < 5Vdc.

Ignition Input: (Orange/Black Wire)

The input is required to enable the siren system. The input is typically connected to the transmission neutral safety switch. If this feature is required, the installer needs to determine if the signal wire from the neutral safety switch is switching the +V or ground side of the circuit. Refer to the programming instructions on how to set the park kill polarity on the siren. Extend the park kill input wire from the siren amplifier to the neutral safety switch using a minimum 22ga. Wire. Park kill Vin Low is < 5Vdc.

Wire capacity requirements for siren amplifier (incoming power)-each supply and ground wire.

- 0-10 Feet: 14 AWG
- 10-20 Feet: 12 AWG
- 20-30 Feet: 10 AWG
- 30+ Feet: Consult Factory to determine requirements

Auxiliary Input: (Violet Wire)

The input is an optional input which will remotely activate the siren when the auxiliary input wire is connected to ground. If this feature is needed, connect the auxiliary input wire to a switch which provides a ground connection when activated. Park Kill disables this option.

Radio Rebroadcast Input: (Blue Wires)

The 2 – 18ga blue wires on the 12 pin Molex connector are used to connect your two-way radio's external speaker through the siren amplifier and broadcast through the warning siren speaker and is optional. Radio Rebroadcast will not work with remotely amplified speakers due to the signal amplitude being too low. Locate the 2 wires that connect the external speaker to the two-way radio. T-tap one blue wire into one of the external speaker wires. T-tap the other blue wire into the other external speaker wire. If the blue wires need to be extended, use a minimum of 20ga. Wire. The Radio Rebroadcast volume must be adjusted prior to placing vehicle into service. Set the volume of the two-way radio to the normal operating level. Press the Radio Rebroadcast push-button on the siren control panel. With a small screwdriver, adjust the radio rebroadcast volume potentiometer located on the back of the siren amplifier to obtain the proper volume out the speaker. Turn potentiometer clockwise to increase volume and counter-clockwise to decrease volume.

Horn Ring Input: (White + White/Black Wire)

The input will allow the operator to control the siren function by pressing the vehicle horn ring. Refer to programming settings for specific configuration options. Refer to wiring diagram for details on how to connect the horn ring input wires to the vehicle's horn ring wiring. If this feature is required, the installer needs to determine if the signal wire from the horn ring is switching the +V or ground side of the circuit. Refer to programming instructions on how to set the horn ring polarity on the siren. Extend the horn ring input wires from the siren amplifier to the horn ring switch using a minimum of 18ga wire. The horn ring circuit is capable of handling a maximum of 5 amps and must be fused by the installer.

Siren Speaker Output: (Orange + Orange/Black Wires), (Green + Green/Black) Route the Orange and Orange/Black wires from the 4 position connector to the siren speaker. Use a minimum of 18ga. wire to extend the wires as needed. Connect the Orange wire to the primary Speaker High wire. Connect the Orange/Black wire to the primary Speaker Low wire. For ETSA462 only connect the Green wire to the secondary speaker High Wire. Connect the Green/Black wire to the secondary speaker Low Wire.

Backlight Input: (Gray Wire)

The input will turn on the backlighting of the control panel whenever +V is applied to the backlight input wire.

Route the siren amplifier backlight input wire to the vehicle's marker light wiring using a minimum of 22ga. Wire to extend as needed. T-tap the backlight input wire into the vehicle's marker light +V wire.

SoundOff
Signal

400 SERIES AMPLIFIER BOX

PSRN4ANR1
PSRN4ANR2

POWERED OUTPUT WIRING

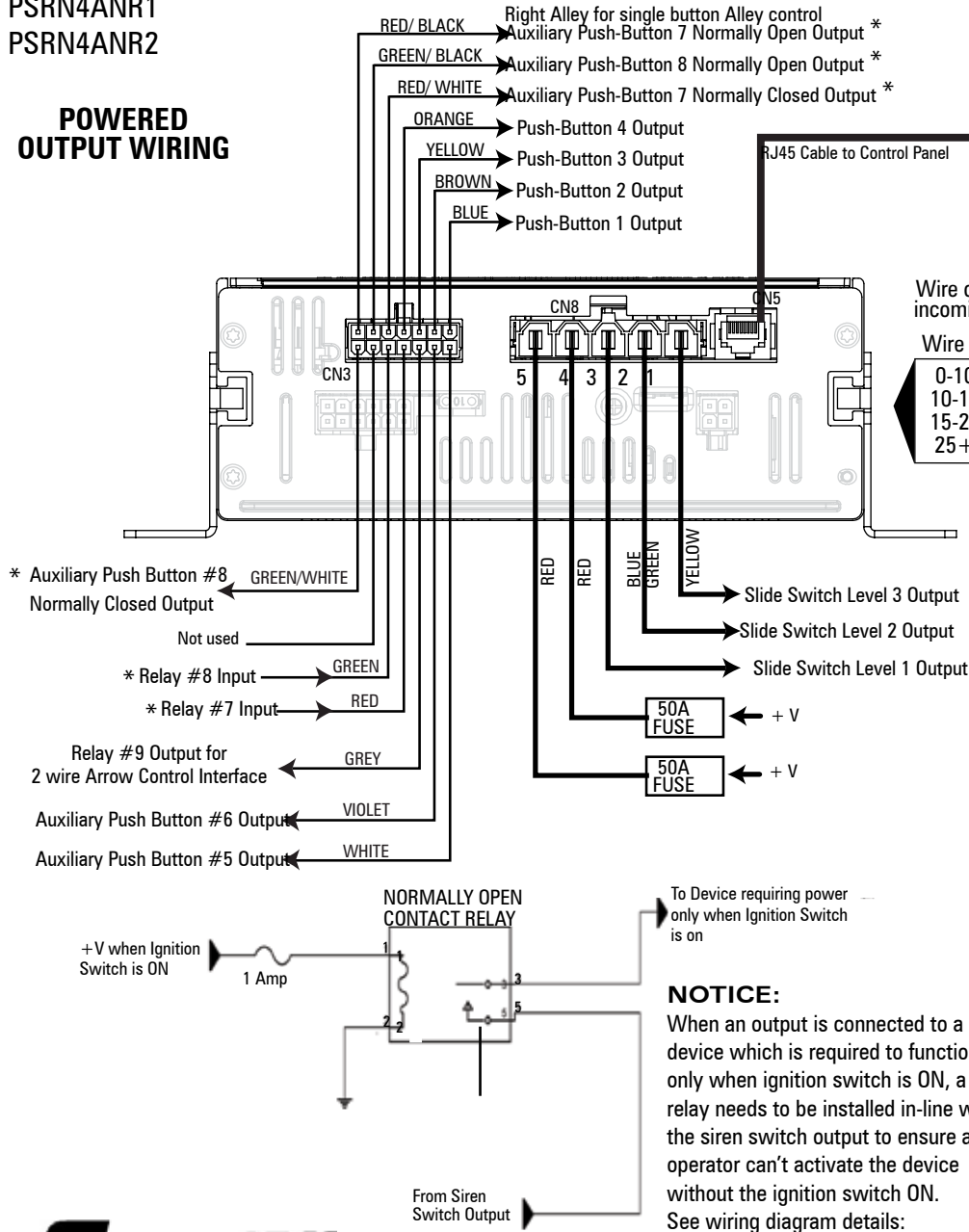

FUSE CHART	
LOCATION	RATING
FB-8	10A
FB-7	10A
FB-4	10A
FB-3	10A
FB-2	10A
FB-1	10A
FB-5	10A
FB-6	10A
FB-9	10A
FS-1	20A
FS-2	20A
FS-3	20A

Internal Relay Board Fuse Replacement:

To replace fuses:

1. Remove power connectors CN8 and CN6 or remove power to unit.
2. Remove unit from console or obtain access to full top of unit.
3. Depress snaps on top cover and lift open.
4. See chart below for output fuse locations and ratings.
5. Fuse Ratings: Replace with same rated part.
6. Close cover, reinstall connectors and reinstall unit in console.

The button outputs 7 and 8 have the ability to receive power from an independent external power source or from the internal +V as supplied to CN8. Both of these outputs use a separate internal 10A mini-ATO fuse which rely on position to determine the source selection. Each fuse may be placed in one of 2 locations. See diagram below.

* If the fuse is placed in the fuse holder near the back edge of the PCB that output will be powered from an external source, labeled "relay #(x) input" on CN3.

** If the fuse is placed in the fuse holder away from the back edge of the PCB that output will be powered from the internal +V source that comes from CN8 pin 5.

FUSE LOCATIONS ON RELAY PCB

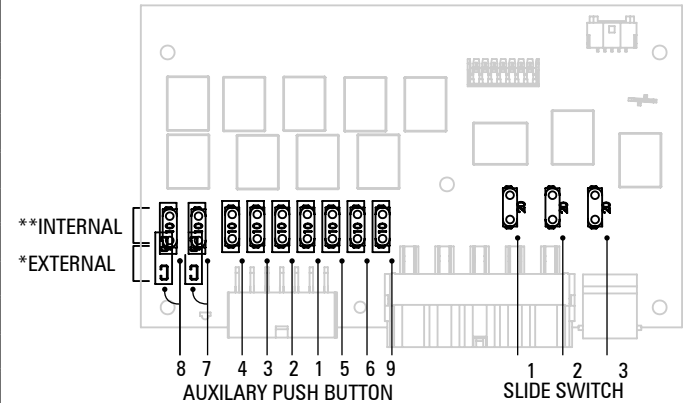

Slide Switch Level Outputs 1-3 and Button Outputs 1-6 are active high (vehicle supply level).



HANDHELD REMOTE

PSRNHHC1

PROGRAMMING MANUAL



LEGEND: ON = ●

Programming Modes

Auxiliary Button Programming:

1. Press and Hold Auxiliary Button #1 and #6 until Level 1 LED Flashes.

2. Press the auxiliary button which setting is going to be viewed/ changed.
3. Monitor the Arrow/Alley LED's to determine setting for Auxiliary Button

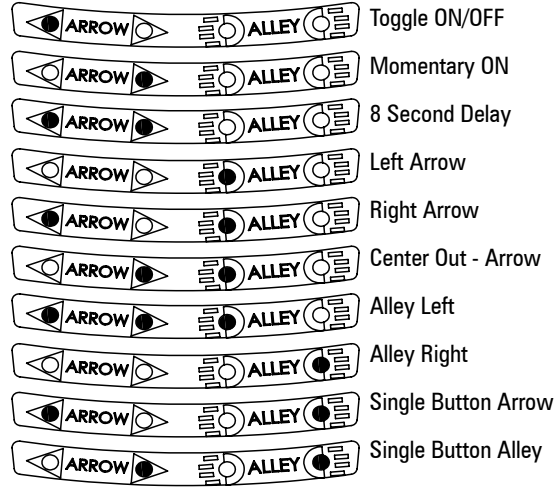

4. Press and release Auxiliary Button until desired mode is selected.
5. Continue steps 2-4 for any other Auxiliary Buttons needing to be programmed.

Default Settings:

Button #1: Single Button Arrow
 Button #2: Single Button Alley
 Button #3-6: Momentary On

Slide Switch Mode:

1. Press and Hold Auxiliary Button #1 and #4 until Level 2 LED flashes.
2. Press Auxiliary switch 1, 2, or 3 depending on required mode of operation.

Aux 1: Progressive 1,2,3
 Level 1 selected: Active Outputs: 1
 Level 2 selected: Active Outputs: 1,2
 Level 3 selected: Active Outputs: 1,2,3

Aux 2: Progressive 1,2,3 with option to turn off lower levels
 Level 1 selected: Active Outputs: 1
 Level 2 selected: Active Outputs: 1,2 (Level 1 may be turned OFF)
 Level 3 selected: Active Outputs: 1,2,3 (Level 1 and 2 may be turned OFF)

Aux 3: Individual 1,2,3
 Level 1 selected: Active Outputs: 1
 Level 2 selected: Active Outputs: 2
 Level 3 selected: Active Outputs: 3

Input Settings:

Press and Hold Auxiliary Button #1 and #3 until LEVEL #3 LED flashes.

1. Park Kill Polarity Mode: Determines what voltage level will activate park kill functions. Disables AUX Input

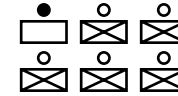

ON = Activated when +V is applied to Park Kill input wire.
 OFF = Activate when Ground is applied to Park Kill input wire

2. Horn Ring Polarity Mode: Determines what voltage level will activate Horn Ring functions.

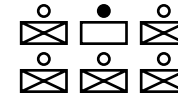

ON = Activated when +V is applied to Horn Ring input wire.
 OFF = Activated when Ground is applied to Horn Ring input wire.

3. PA Volume Control (see Setting PA Volume)

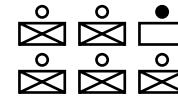

ON = RR Button Adjustable.
 Note: This requires pressing and holding RR Button for RR function ability.
 OFF = Programmed

4. Level 3 Tone Activation : Determines when the siren push-button on control panel are enabled.

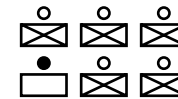

ON = Siren push button always enabled
 OFF = Tone push button only enabled when slide relay #3 is active.

5. 8 Second Buzzer Alert: Provides audible beep once every 8 seconds when any auxiliary switches are ON or level 1, 2 or 3 is active.

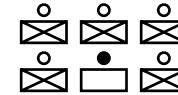

ON = Enabled
 OFF = Disabled

6. Air Horn Button Output Channels

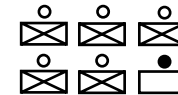

ON = In standby mode, Air Horn tone is output on Spkr A & B. When Warning Tone is Active, Warning Tone continues on Spkr A & Air Horn Button Tone is output on Spkr B.
 OFF = Air Horn Button Tone always produced on Spkr A & B.

NOTE:

For All programming modes: Momentarily depress Radio Rebroadcast push-button to save and exit.

To hear samples of all the tones available go to www.soundoffsignal.com website.

Denotes Factory Default Setting



HANDHELD REMOTE

PSRNHHC1

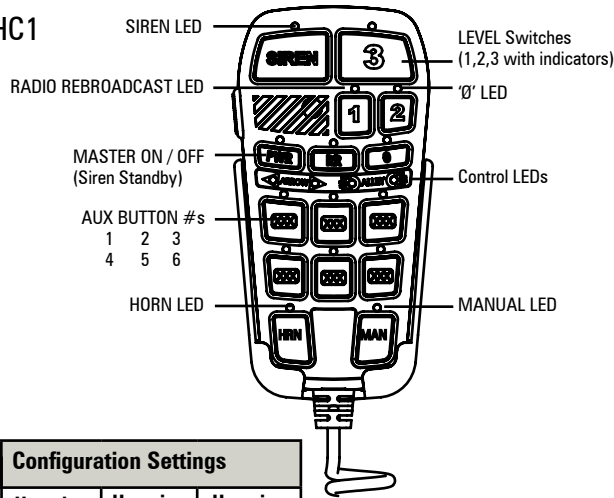

Configuration Settings					
		Horning Scroll	Horning Latch	Horning Timeout	Output Behavior
Modes	Scroll	ON	X	OFF	Pressing the horn in this mode will advance to and latch the next priority tone. (W->Y->T->W...). The tone is cancelled by pressing the control panel standby or siren tone buttons.
				ON	Same as above with the added feature of the tone being cancelled 8 seconds after the horn is released.
	Latch/Toggle	OFF	ON	OFF	Pressing the horn in this mode will toggle between the current control panel tone and the next priority tone. If the tone can not transfer to a higher priority tone, the airhorn will sound while the horn is pressed.
				ON	Same as above with the added feature of the tone being cancelled 8 seconds after the horn is released.
	Momentary	OFF	OFF	OFF	Pressing the horn in this mode will momentarily play the next priority tone while the horn is held.
				ON	Same as above with the added feature of the tone being cancelled 8 seconds after the horn is released.

ALTERNATE HORN RING CONTROL			
	OPTION 1	OPTION 2	
STANDBY	OEM HORN	OEM HORN	
LEVEL 1	OEM HORN	OEM HORN	
LEVEL 2	Air Horn or Manual Button Tone while Pressed *	Tap to Turn On Warning Tone, Tap again to Change Warning Tone. Press and Hold for Air Horn Tone	
LEVEL 3	Tap to turn ON Warning Tone, Tap again to change Warning Tone. Press and Hold for Air Horn Tone	TONE SWITCH OFF: Air Horn Tone or Manual Button Tone while Pressed *	TONE SWITCH ON: Tap to change Warning Tone, Press and Hold for Air Horn Tone

* Set in "Horn Ring Program" 3. Horn Ring Standby Tone

Other Modes:

Press and Hold Auxiliary Button #1 and #5 until LEVEL #1 and LEVEL #3 indicator LED flashes.

1. Horn Ring Activation: Determines when pressing the Vehicle Horn will activate siren tone.

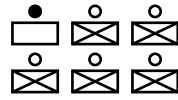

ON = Enabled whenever siren is on.
OFF = Enabled only when level 3 is activated.

2. Buzzer: Audible tone from control panel whenever operator presses push-button or changes position of slide/rotary switch.

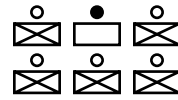

ON = Enabled
OFF = Disabled

3. Park Kill Latch: When Park Kill input is triggered, determines how siren tone proceeds once park kill input is no longer active.

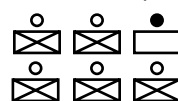

ON = Tone remains disabled until operator selects other tone.
OFF = Tone resumes once Park Kill input is no longer active

4. Power Down: Determines whether siren will operate when ignition input has no voltage.

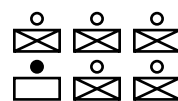

ON = Siren will operate w/o voltage on ignition input, turn off after 10 minutes of no activity.
OFF = Siren is disabled when no voltage is present on ignition input

5. Auxiliary Input: Determines which siren tone will activate when auxiliary input is activated.

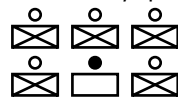

ON = Air Horn tone
OFF = Tone which is programmed on Wail push-button

6. Power On Option: Determines requirements to enable siren. If running without ignition, need Other Modes #4 enabled.



ON = Requires power button to be held for 2 seconds to turn on the system.
OFF = System will turn on with either ignition or a power button press of any length.

Horn Ring Program:

Press and Hold Auxiliary Button #3 and #4 until 'Ø' LED flashes.

1 Horn Ring Scroll.

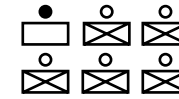

ON = Tone will advance through tones programmed on Wail, Yelp, and Tone push-buttons each time vehicle horn is pressed.
OFF = Tone will toggle between control panel tone and next priority tone. If tone can not transfer to higher priority tone, Airhorn will momentarily play.

2. Horn Ring Latch Mode: (Alternate Horn Ring Control and Scroll Mode Must be Disabled) Activates the siren tone per scroll mode off settings when operator momentarily presses on Vehicle Horn.

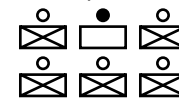

ON = Horn Ring Toggle Switch Mode
OFF = Horn Ring Momentary Switch Mode

3. Horn Ring Standby Tone: (Alternate Horn Ring Control Must be Disabled). Determines which tone to output when siren is in standby and vehicle horn is pressed.

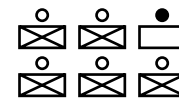

ON = Air Horn Tone
OFF = Manual Button Tone

4. Horn Ring Timeout: (Alternate Horn Ring control must be disabled for function to have any effect). When vehicle horn is pressed and tone changes, determines how tone will change back to pre-vehicle horn press tone. This feature can be applied to scroll and latch modes.

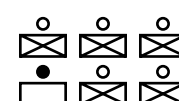

ON = Siren tone will revert back to pre-vehicle horn tone after 8 seconds.
OFF = Siren tone will not revert back to pre-vehicle horn press tone.

5. Alternate Horn Ring Control: Custom operation of vehicle horn when pressed. Refer to figure at left for details.

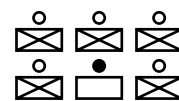

ON = Enabled
OFF = Disabled

6. Alternate Horn Ring Control Option: (Alternate Horn Ring Control must be enabled). Custom operation of vehicle horn when pressed. Refer to figure at left for details.

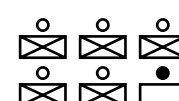

ON = Option 2
OFF = Option 1

HANDHELD REMOTE

PSRNHHC1

Setting PA Volume:

Check PA Volume Control (see Input Settings, 1-3)

If set to "Programmed"

Press and Hold Auxiliary Button #1 and #2 until LEVEL #2 and LEVEL #3 LED flashes.

- a. Depress and hold PA switch on microphone and press Pushbutton 1-6 depending on volume required. When correct volume is determined, press Radio Rebroadcast and the volume setting will be permanently stored.

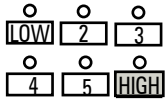

If set to "RR Button Adjustable"

Momentarily press RR Button to select PA Volume. PA Volume will be displayed on indicators below RR Button.

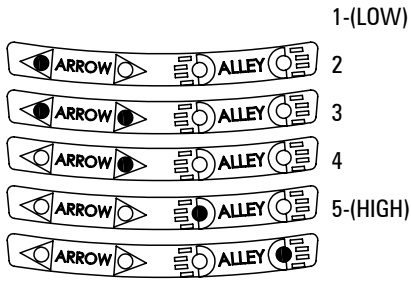

AUXILLARY AND LEVEL SWITCH LED INDICATORS:

LED INDICATOR	CONDITION
OFF	RELAY OUTPUT IS OFF
ON	RELAY OUTPUT IS ON
FLASHING	RELAY OUTPUT HAS A FAULT

SIREN AMPLIFIER DIAGNOSTIC INDICATORS:

POWER LED	SIREN LED	HORN LED	MANUAL LED	CONDITION
ON	FLASHING	OFF	ON	UNDER-VOLTAGE
ON	FLASHING	ON	OFF	OVER-VOLTAGE
ON	FLASHING	FLASHING	-	COMM FAULT - RELAY
ON	FLASHING	-	FLASHING	COMM FAULT - AMP
ON	FLASHING	FLASHING	FLASHING	COMM FAULT -RELAY AND AMP
FLASHING	FLASHING	FLASHING	FLASHING	SEE NOTE
ON	OFF	-	-	STANDBY MODE
OFF	ON	ON	-	SPKR 1 IS ACTIVE
OFF	ON	OFF	-	SPKR 1 IS NOT-FUNCTIONING
OFF	ON	-	ON	SPKR 2 IS ACTIVE
OFF	ON	-	OFF	SPKR 2 IS NOT-FUNCTIONING

NOTE:

If after start-up the diagnostic LEDs and middle 3 arrow LEDs are flashing, the control panel is in a special bluePRINT mode. Press and hold AUX 1, 3 and 5 for 2 seconds to return to normal operation.

Level Switch Mapping:

1. Press Auxiliary Buttons #4 and #5 until RR LED Flashes
2. Press Level 1,2, or 3 switch to select level to be programmed
3. Press Auxiliary Buttons #1-#6 as required. LED ON = function will turn ON when Level is active
4. Press siren button for desired tone to be generated for level

Default - All level #'s produce no tone

Alley Left = Tone 1
 Alley right = Tone 2
 Alley Left and Right = Tone 3

5. Press the Radio Rebroadcast button to exit programming mode.

Setting Backlight/Indicator LED Intensity:

1. Press and Hold Radio Rebroadcast (RR) Button.
2. Then press Aux Buttons 1-6 to select intensity.
 - 1 = Low Intensity
 - 6 = High Intensity

Park Kill Settings:

Enables auxiliary and slider outputs to be disabled when Park Kill input is active. Auxiliary outputs can be turned back on by pushing the buttons again; slider outputs are disabled as long as the Park Kill input is active.

1. Push and hold Auxiliary Push-Buttons 2 & 3.
2. Press Push-Button to 1-6 to toggle whether that auxiliary output will turn off when Park Kill input becomes active. LED on means output will turn off.
3. Press slider button 1, 2 or 3. Press the Manual button to toggle whether that output relay is disabled while Park Kill is active. LED on means that relay will be off. E.g: if LED for slide position 3 is on, Slide Switch Level 3 Output will be disabled; Level 1 & 2 outputs can still be on when slider is in position 3.
4. Repeat step 3 as needed.
5. Press the Radio Rebroadcast button to exit programming mode.

NOTE: Does not affect buttons programmed as momentary, 8 Second On Time or Alley.



TONE #1

BUTTON #2	BUTTON #4	BUTTON #5	BUTTON #6	SPKR A	SPKR B
X	OFF	OFF	OFF	WAIL 1	WAIL 1
X	OFF	OFF	ON	WAIL 2	WAIL 2
X	OFF	ON	OFF	WAIL 1	WAIL 2
X	OFF	ON	ON	WAIL 1	YELP 1
X	ON	OFF	OFF	WAIL 1	ALERT A
X	ON	OFF	ON	WAIL 1	HiLo
X	ON	ON	OFF	WAIL 2	SUPER HiLo
X	ON	ON	ON	WAIL 2	PIERCER
ON	OFF	OFF	OFF	DISABLE	DISABLE

TONE #2

BUTTON #2	BUTTON #4	BUTTON #5	BUTTON #6	SPKR A	SPKR B
X	OFF	OFF	OFF	YELP 1	YELP 1
X	OFF	OFF	ON	YELP 2	YELP 2
X	OFF	ON	OFF	YELP 1	YELP 2
X	OFF	ON	ON	YELP 1	WAIL 1
X	ON	OFF	OFF	YELP 1	PIERCER
X	ON	OFF	ON	YELP 1	HiLo
X	ON	ON	OFF	YELP 2	SUPER HiLo
X	ON	ON	ON	YELP 2	PIERCER
ON	OFF	OFF	OFF	DISABLE	DISABLE

MANUAL BUTTON (SOLO PLAY ONLY)

BUTTON #4	BUTTON #5	BUTTON #6	SPKR A/B
OFF	OFF	OFF	WAIL 1 FREQUENCY DECREASE WHEN RELEASED
OFF	OFF	ON	WAIL 1 IMMEDIATE OFF WHEN RELEASED
OFF	ON	OFF	YELP 1
OFF	ON	ON	PIERCER
ON	OFF	OFF	ALERT A
ON	OFF	ON	HiLo
ON	ON	OFF	SUPER HiLo

TONE #3

BUTTON #2	BUTTON #3	BUTTON #4	BUTTON #5	BUTTON #6	SPKR A	SPKR B
X	OFF	OFF	OFF	OFF	TONE SCROLL*	TONE SCROLL*
X	OFF	OFF	OFF	ON	PIERCER	PIERCER
X	OFF	OFF	ON	OFF	HiLo	HiLo
X	OFF	OFF	ON	ON	SUPER HiLo	SUPER HiLo
X	OFF	ON	OFF	OFF	ALERT A	ALERT A
X	OFF	ON	OFF	ON	ALERT A	HiLo
X	OFF	ON	ON	OFF	ALERT A	SUPER HiLo
X	OFF	ON	ON	ON	HiLo	SUPER HiLo
X	ON	OFF	OFF	OFF	HiLo	PIERCER
X	ON	OFF	OFF	ON	ALERT A	ALERT B
X	ON	OFF	ON	OFF	PIERCER	YELP 1
X	ON	OFF	ON	ON	PIERCER	WAIL 1
X	ON	ON	OFF	OFF	SUPER HiLo	PIERCER
X	ON	ON	OFF	ON	WAIL 1	WAIL 2
X	ON	ON	ON	OFF	YELP 1	YELP 2
X	ON	ON	ON	ON	WAIL 1	YELP 1
ON	OFF	OFF	OFF	OFF	DISABLE	DISABLE

HORN BUTTON

BUTTON #3	BUTTON #4	BUTTON #5	BUTTON #6	SPKR A	SPKR B
OFF	OFF	OFF	OFF	HORN 1	HORN 1
OFF	OFF	OFF	ON	HORN 2	HORN 2
OFF	OFF	ON	OFF	HORN 3	HORN 3
OFF	OFF	ON	ON	HORN 4	HORN 4
OFF	ON	OFF	OFF	HORN 1	HORN 2
OFF	ON	OFF	ON	HORN 1	HORN 3
OFF	ON	ON	OFF	HORN 4	HORN 1
OFF	ON	ON	ON	HORN 2	HORN 3
ON	OFF	OFF	OFF	HORN 2	HORN 4
ON	OFF	OFF	ON	HORN 3	HORN 4
ON	OFF	ON	OFF	HORN 1	WAIL 1
ON	OFF	ON	ON	HORN 1	YELP 1
ON	ON	OFF	OFF	HORN 1	PIERCER
ON	ON	OFF	ON	HORN 2	YELP 1
ON	ON	ON	OFF	HORN 3	YELP 1
ON	ON	ON	ON	HORN 4	SUPER HiLo

Tones Program:

- Press and Hold Buttons #2 and #5 until Level 1, Level 2 and Level 3 LEDs flash.
- Press SIREN button to program the tones (each press of the SIREN button will advance to next TONE mode). Note: in operation, each press of the SIREN button will scroll between the programmed tones.
- SIREN Mode:

SIREN TONE #1	Siren LED
SIREN TONE #2	PWR LED
SIREN TONE #3	Siren LED and PWR LED
- Press Auxiliary Buttons to get required tone
- HORN Button:
Press Horn Button and HORN 1 LED will turn ON
Press Auxiliary Buttons to get required tone.
- Man Button:
Press MAN Button and MANUAL LED will turn ON
Press Auxiliary Buttons to get required tone.

Manual Button Tone Duration:

MOMENTARY: When played solo

LATCHED: When played over other tones.



400 SERIES REMOTE AMPLIFIER SIREN W/ HANDHELD REMOTE

ETSA461HPP - 100W

ETSA462HPP - 200W

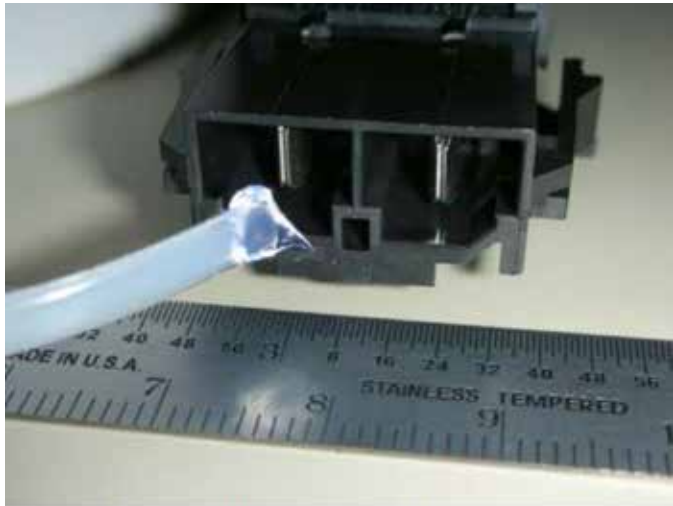

Carefully insert Nyogel 760G into the housing.

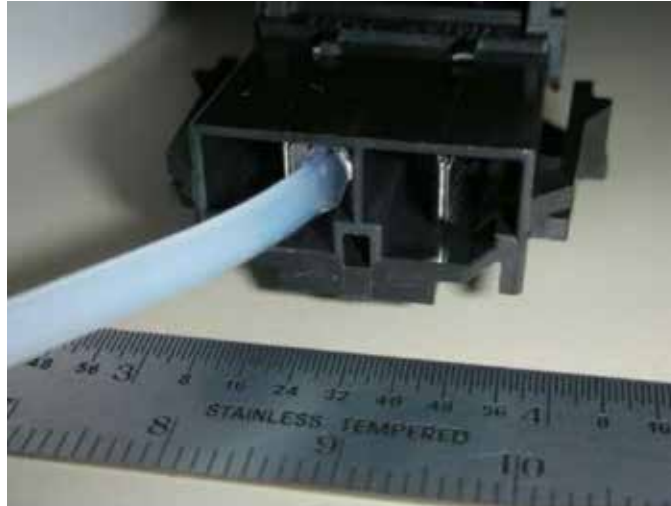

Apply Nyogel 760G to both sides of every male terminal.

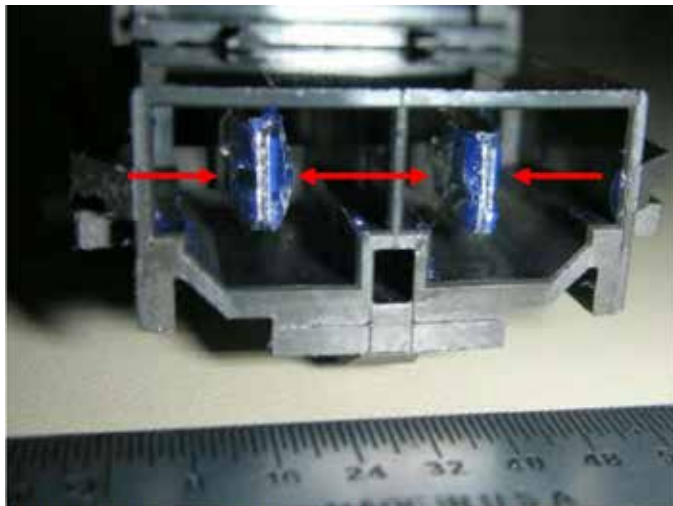

Photo of Nyogel 760G applied to both sides of each male terminal, covering the contact areas.

⚠ WARNING

Dielectric grease must be applied to
connector CN8.

NOTICE:

Installers and users must comply with all applicable federal, state and local laws regarding use and installation of warning devices.

Improper use or installation may void warranty coverage.

To review our Limited Warranty Statement & Return Policy for this or any SoundOff Signal product, visit our website at www.soundoffsignal.com/tech-services/returns/.
If you have questions regarding this product, contact **Technical Services**, Monday - Friday, 8 a.m. to 5 p.m. or after hours 5 p.m. to 8 p.m. ET at 1.800.338.7337 (press #4).
Questions or comments that do not require immediate attention may be emailed to techservices@soundoffsignal.com.

Dielectric Grease on Molex Connectors

Introduction

Molex has advised to add dielectric grease for "Mini-Fit Sr." connectors. On the SoundOff Signal 400 Series Sirens this includes the Connector (CN8) on the back of the siren. Connector CN8 is used on the 400 Series Sirens to supply power to the Slide and Auxiliary outputs of the siren. This connector is a member of the "Mini-Fit Sr." family manufactured by Molex. The dielectric grease / lubricant should be applied to these tin-plated terminals that are used for CN8 and/or the mating connector included with the Siren. The application of the grease should take no more than 5 minutes for each siren.

Application Instruction

The dielectric grease should be applied after all crimping, soldering, and assembly is complete. It should be applied to all five (5) terminals. Care must be taken to prevent any scratching or damage to the plating in the contact area. Avoid contamination from dust, dirt, or other materials.

Molex recommends Nye lubricant, Nyogel 760G and provides detailed instructions in this application specification:

https://www.molex.com/pdm_docs/as/AS-42815-001.pdf

A single use packet of Nyogel 760G has been included in the siren harness kit for application.

NYLEX SAFETY DATA SHEET: https://www.nyelubricants.com/datasheet/SDS_US_English_NYOGEL+760G.pdf

NOTE:

The mating harness that has been included in the kit uses correctly matched tin plated terminals. Do not mix terminals with other plating types such as silver or gold.

**SoundOff
Signal**

1.800.338.7337 / www.soundoffsignal.com

SUPERIOR CUSTOMER RELATIONSHIPS. SMARTLY DESIGNED LIGHTING & ELECTRONIC SOLUTIONS.